

规格书

Specifications

品名 Name	2 位数码管 2 Digit Seven-segment LED Display
型号 Model	YD-S5621A (共阴 Share Cathode)
	YD-S5621B (共阳 Share Anode)
发光颜色 Color	红-R 超亮红-SR 黄绿-G 黄-Y 蓝-B 翠绿-PG 白-W Red-R, Super Red-SR, Yellow Green-G, Yellow-Y, Blue-B, Pure Green-PG, White-W
8 字高度 "8" Height	0.56 英寸 14.20mm 0.56inch, 14.20mm
总芯片数 Total LED Chips	16
表面颜色 Cover Color	黑色 Black
胶体颜色 Colloid Color	乳白/红 Ivory/Red
备注 Remark	

宜兴市宇达电子有限公司
YiXing YuDa electronics co., Ltd

地址：江苏省宜兴市新芳工业集中区

Address: XingFang Industrial park, YiXing, JiangSu

Phone: 0510-87266000 Fax: 0510-87266667

Website: <http://www.yxyuda.cn>

Email: yxyuda@163.com

一.特性描述 (Characteristics)

- ★★★ 能在低电压、小电流条件下驱动发光
Lower working voltage and current
- ★★★ 发光响应时间极短($<0.1 \mu s$),高频特性好,单色性好,亮度高
Lighting answering Time $<0.1 \mu s$, better high frequency, chromaticity uniformity, high brightness.
- ★★★ 体积小,重量轻,抗冲击性能好. 固态封装, 封装方式为灌胶型,稳定性高
Smaller volume, lighter weight, better impact resistance, solid sealing, good steady.
- ★★★ 寿命长,使用寿命在 5 万小时以上
Long life for 50,000 hours.
- ★★★ 可连续扫描驱动各字节
Keep scanning and driving every segment continuously.
- ★★★ 良好的显示效果、视角宽
Better showeffect and wider visual angle.
- ★★★ 推荐恒流使用,恒压会出现亮度不均匀现象
Recommend constant current driver.
- ★★★ 表面有保护膜的产品,可以在使用前撕下来
Protective coating, and rip off when using.
- ★★★ 焊接温度: 260°C 停留时间最长 5 秒
Solder temperature: 260°C ,and stay time less than 5 seconds.
- ★★★ 当工作温度高于 25°C 时, I_{fm} , I_{fp} 和 I_d 必须降低;电流降低率是 $-0.36\text{mA}/^{\circ}\text{C}$ (直流驱动), 或 $-0.86\text{mA}/^{\circ}\text{C}$ (脉冲驱动) 功耗率是 $-0.75\text{mW}/^{\circ}\text{C}$ 。产品的工作电流不能大于对应工作温度条件 I_{fm} 或 I_{fp} 的 60%。
For operation above 25°C , The I_{fm} I_{fp} & P_d must be derated, the Current derating is $-0.36\text{mA}/^{\circ}\text{C}$ for DC drive and $-0.86\text{mA}/^{\circ}\text{C}$ for pulse drive, the power dissipation is $-0.75\text{mW}/^{\circ}\text{C}$. The product working current must not more than the 60% of the I_{fm} or I_{fp} according to the working temperature.
- ★★★ 蓝色,翠绿色,白色请采取防静电措施
Electrostatic prevention for Blue, Pure Green and White ones.

二. 极限参数 (Limited Parameters)

参数 Parameters	符号 Symbol	极限参数 Limited parameter
脉冲电流 Peak Forward Current	Ifp	100mA
直流电流 Continuous Forward Current	If	10 mA
反向电压 Reverse Voltage	Vr	5V
工作温度 Operating temperature Range	Topr	-25 to +70°C
储存温度 Storage temperature Range	Tstg	-40 to +85°C

三. 光电参数 (Photoelectric Parameters)

参数 Parameter	正向电压 Forward voltage		反向电流 Reverse current		发光强度 Luminous Intensity	波长 Wavelength	功耗 Power consumption
	符号 Name	VF	IR		IV	λ_p	Pt
单位 Unit	V		uA		mcd	nm	mW
条件 Condition	IF=20 mA		VR=5V		IF=20mA	IF=20mA	IF=20mA
	平均 Arrange	最大 Max.	平均 Arrange	最大 Max.	平均 Arrange	平均 Arrange	平均 Arrange
高亮红 High red R	2	2.4	--	20	11	635	36
超高亮红 super red SR	2.2	2.6	--	20	80	620	40
黄绿色 Yellow green G	2.2	2.6	--	20	11	571	44
黄色 Yellow Y	2.1	2.5	--	20	85	590	42
蓝色 Blue B	3.3	4	--	20	12	465	66
翠绿色 Pure green PG	3.3	4	--	20	220	515	66
白色 White W	3.3	4	--	20	--	--	66

四.外形尺寸及电路原理图: 25.00mm×19.00mm×8.00mm

Figure Size & Circuit Principle Diagram: 25.00mm×19.00mm×8.00mm

5621A

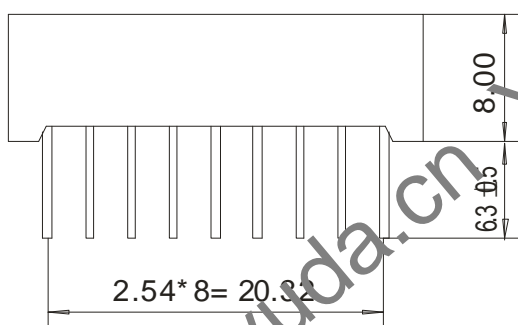
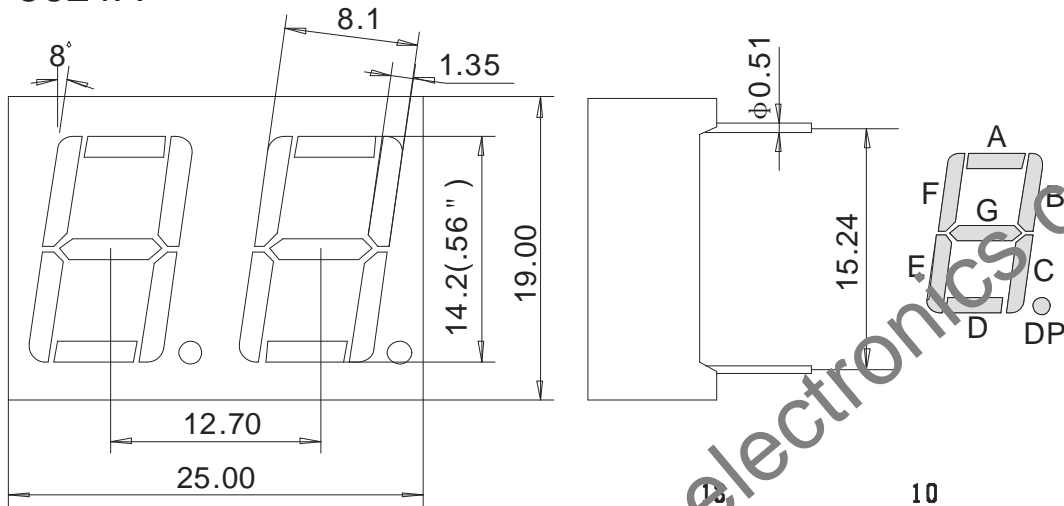

数码管显示及引脚位置图

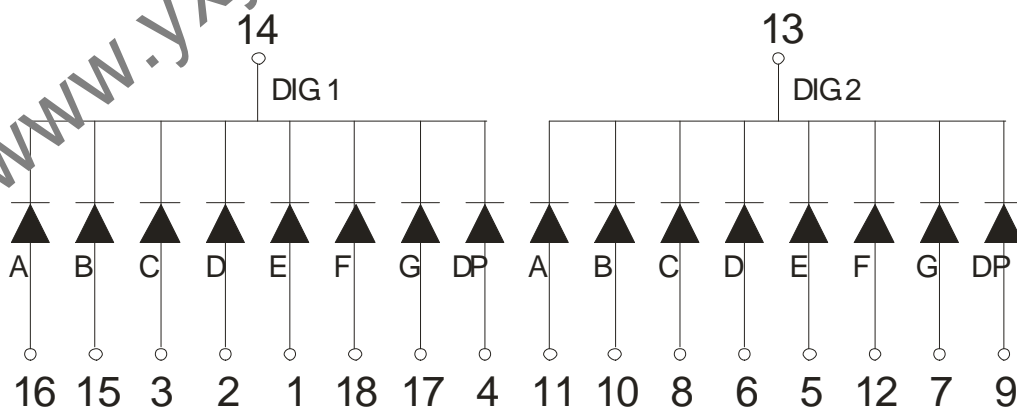

段驱动电压为：正向电压×1

Segment driver voltage: VF value x 1

小数点驱动电压为：正向电压×1 不同颜色的正向电压值不同,详见第二页光电参数表。

Decimal driver voltage: VF value x 1, different colors with different forward voltage, please refer to Photoelectric Parameters.

5621B

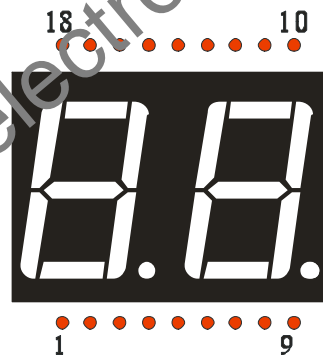
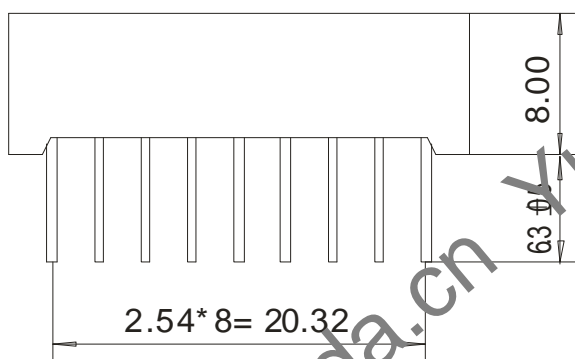
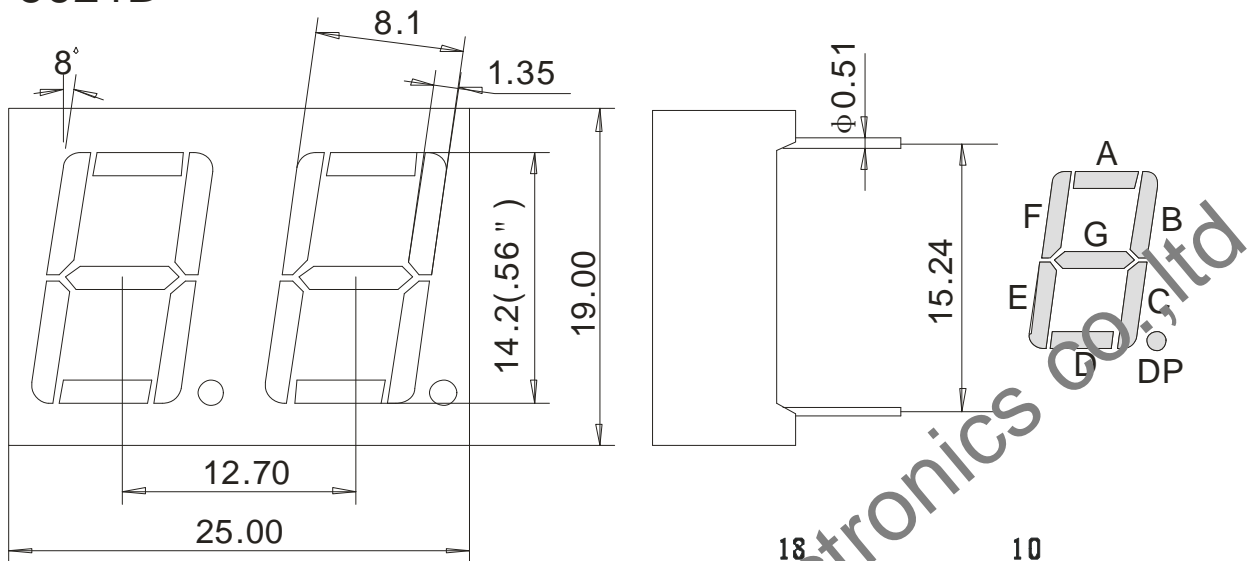

数码管显示及引脚位置图

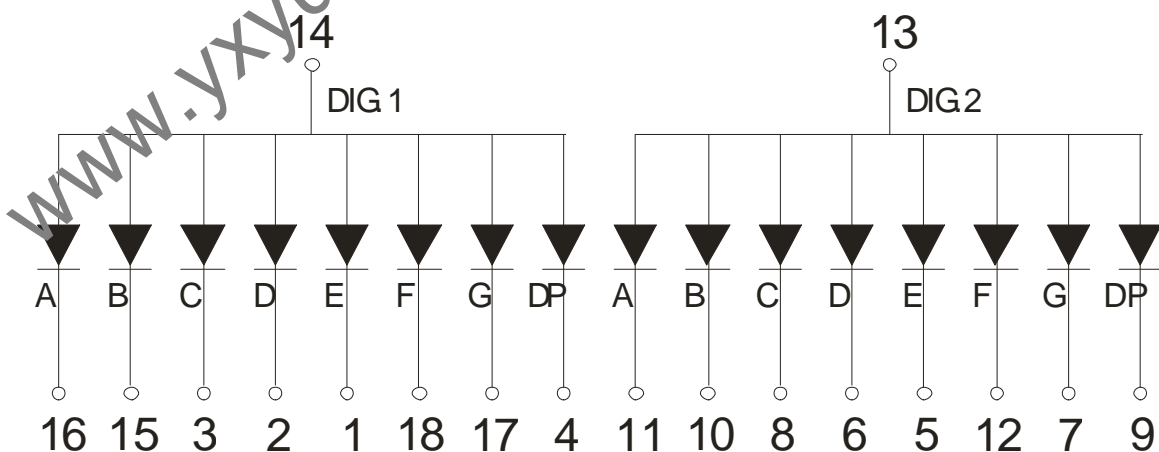

段驱动电压为：正向电压×1

Segment driver voltage: VF value x 1

小数点驱动电压为：正向电压×1 不同颜色的正向电压值不同,详见第二页光电参数表。

Decimal driver voltage: VF value x 1, different colors with different forward voltage, please refer to Photoelectric Parameters.